

EGGENBERG
INDUSTRIAL TOOLS

BANDZAAGMACHINE METAAL



EBS2480
MANUAL

SAFETY RULES

WARNING: When using electric tools basic safety precautions should always be followed to reduce the risk of fire, electric shock and personal injury!

As with all machinery there are certain hazards involved with operation and use of the machine. Using the machine with respect and caution will considerably lessen the possibility of personal injury. However, if normal safety precautions are overlooked or ignored, personal injury to the operator may result. This machine was designed for certain applications only. We strongly recommends that this machine NOT be modified and/or used for any application other than for which it was designed. If you have any questions relative to its application DO NOT use the machine until you contact with us and we have advised you.

Read all the following instructions before attempting to operate this product and save these instructions!

1. Keep work area clear
 - Cluttered areas and benches invite injuries.
2. Consider work area environment
 - Do not expose tools to rain.
 - Do not use tools in damp or wet locations.
 - Keep work area well lit.
 - Do not use tools in the presence of flammable liquids or gases.
3. Guard against electric shock
 - Avoid body contact with earthed or grounded surfaces.
4. Keep other persons away
 - Do not let persons, especially children, not involved in the work touch the tool or the extension cord and keep them away from the work area.
5. Store idle tools
 - When not in use, tools should be stored in a dry locked-up place, out of reach of children.
6. Do not force the tool
 - It will do the job better and safer at the rate for which it was intended.
7. Use the right tool
 - Do not force small tools to do the job of a heavy duty tool.
 - Do not use tools for purposes not intended; for example do not use circular saws to cut tree limbs or logs.
8. Dress properly
 - Do not wear loose clothing or jewellery, they can be caught in moving parts.
 - Non-skid footwear is recommended when working outdoors.
 - Wear protective hair covering to contain long hair.
9. Use protective equipment
 - Use safety glasses.
 - Use face or dust mask if cutting operations create dust.
10. Connect dust extraction equipment
 - If device are provided for the connection of dust extraction and collecting equipment, ensure these are connected and properly used.
11. Do not abuse the cord
 - Never yank the cord to disconnect it from the socket. Keep the cord away from heat, oil and sharp edges.
12. Secure work
 - Where possible use clamps or a vice to hold the work. It is safer than using your hand.
13. Do not overreach
 - Keep proper footing and balance at all times.
14. Maintain tools with care
 - Keep cutting tools sharp and dean for better and safer performance.
 - Follow instructions for lubricating and changing accessories.
 - Inspect tool cords periodically and if damaged have them repaired by an authorized service facility.
 - Inspect extension cords periodically and replace if damaged.
 - Keep handles dry dean and free from oil and grease.
15. Disconnect tools
 - When not in use, before servicing and when changing accessories such as blades, bits and cutters disconnect tools from the power supply.
16. Remove adjusting keys and wrenches
 - Form the habit of checking to see that keys and adjusting wrenches are removed from the tool before turning it on.
17. Avoid unintentional starting
 - Ensure switch is in "off " position when plugging in.
18. Use outdoor extension leads
 - When the tool is used outdoors, use only extension cords intended for outdoor use and so marked.
19. Stay alert
 - Watch what you are doing, use common sense and do not operate the tool when you are tired.
20. Check damaged parts
 - Before further use of tool, it should be carefully checked to determine that it will operate properly and perform its intended function.
 - Check for alignment of moving parts, binding of moving parts, breakage of parts, mounting and any other conditions that may affect its operation.
 - A guard or other part that is damaged should be properly repaired or replaced by an authorized service centre unless otherwise indicated in this instruction manual.
 - Have defective switches replaced by an authorized service centre.
 - Do not use the tool if the switch does no turn it on - and off.
21. Warning
 - The use of any accessory or attachment other than one recommended in this instruction manual may present a risk of personal injury.
22. Have your tool repaired by a qualified person
 - This electric tool complies with the relevant safety rules. Repairs should only be carried out by qualified persons using original spare parts, otherwise this may result in considerable danger to the user.

SPECIFICATIONS

EBS2480

Capacity	(mm)	90°	● 225 ■ 245 x 180
		60°	● 100 ■ 100 x 100
		45°	● 160 ■ 160 x 160
Speeds	(MPM)		45 / 90
Motors		Saw	<i>Customed</i>
			400V,50Hz,3 Phases
		Coolant	100W
			400V,50Hz,1 Phase,0.16A
Blade	(mm)		27 x 0.9 x 2480
Blade Wheels	(mm)		292 (<i>Hight strength flanged cast iron</i>)
Dimensions	(mm)	Length	1500
		Width	510
		Height	935 (<i>Cutting area</i>)
		Height	1570 (<i>Total</i>)
Packing			1380 x 580 x 930
Weight	(kg)		200 / 216
Miter Scale			0 ~ 60°
Noise	(dB)		70 (<i>Weighted sound pressure level</i>)
Fuse			max. 16A

ATTENTION!

Because there is no built in fuse in this saw, the saw has to be fused by the fuse of the building installation. The maximum value of the building installation fuse has to be 16A.

FEATURES

1. Special designed horizontal band saw.
2. Offers two speeds for cutting metal.
3. With cooling pump for prolongation of the saw blade life.
4. With trigering knob at the handle for easy and safe use.
5. With scale for the mitering vise and graduation.
6. Stand for safe use.

DELIVERY

1. Transportation to desired location before unpacking, please use lifting jack.
2. Unpack all the parts.
3. Transportation after unpacking, please use heavy duty fiber belt to lift up the machine.
Always keep proper footing and balance while moving this machine.
As this machine weights 157kgs it is recommended that the machine be transported with help of lifting jack.

INSTALLATION

1. Position the base of the machine on a solid cement floor and then fix it to the ground.
2. Put the bandsaw at the base and fasten it with the delivered screws.
3. Secure the cutting head by the safety lever.
4. Assemble the roller holding arm.
5. Tighten all locks before operation.
6. Check carefully if the sawblade is running in counter-clockwise direction. If not, exchange two wires at the plug. Then repeat the running test.
7. Make sure that the blade is not impeded in any way.
8. Position the adjustable blade guide to its most left position. Turn the blade tension handwheel to tighten the blade. Correct tension will be reached, if the sawblade can be pushed for 3 mm in the middle of the cutting area with a force of 50 N.
Please note! Incline the handle of the blade tension handwheel in such manner, that hitting of the handwheel of the vice is impossible.
9. Fill the tank with coolant liquid by using a mixture of water and oil in the 7-10% percentage.
10. Check that the mains voltage corresponds to that reported on the motor.

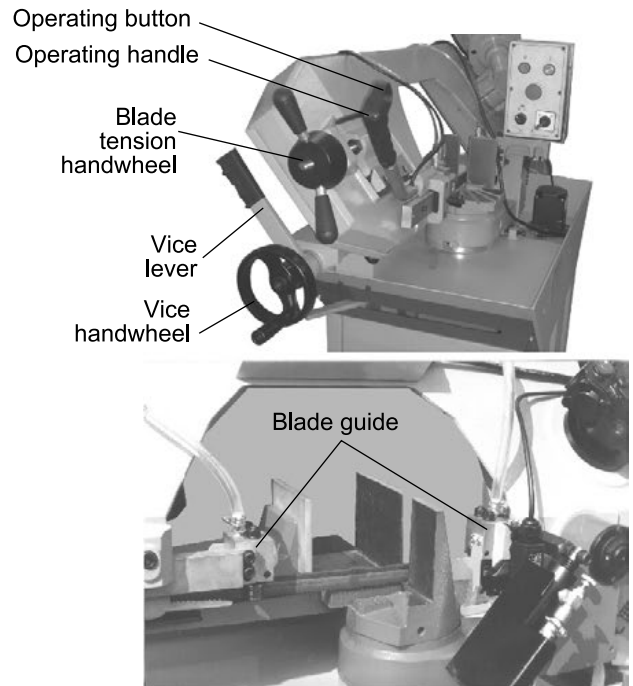

WORKING WITH THIS MACHINE

1. Position the vice about 4 mm from the workpiece by operating the vice handwheel.
2. Clamp the workpiece in the vice completely by turning the vice lever.
3. Position the adjustable blade guide head as near as possible to the workpiece.
4. Operate the speed switch by selecting the appropriate speed:
 - in the 1st pos. the cutting speed is 45 m/min
 - in the 2nd pos. the cutting speed is 90 m/min
5. Connect the cable to the mains according to the mains according to the accident-prevention standards.

ATTENTION: GROUND WIRE.

6. Choose, if you would like to use coolant or not. For pumping coolant, please turn the switch with the inscription coolant to the "I"-position. If you do not wish to use coolant, turn this switch to the "O"-position.

ATTENTION:

Before start the machine, make sure, that blade is suitable to workpiece specifications. Make also sure that all protective covers are installed and tighten correctly by screws.

7. Unsecure the cutting head.
8. After that, lead down the cutting head to about 5 mm to the workpiece, press the operating button of the handle to start the rotation of the blade and to start the cooling system.
9. There are two different control systems of this saw:
 - : The push button at the handle is a trigger button. That means, the saw is working, as long as the button is pushed. If the push button is released, the saw and the coolant will stop.
 - : The push button at the handle start the saw and the coolant. Both will be stopped, if the cut is done and the limit switch was pressed automatically. In case that anything will happen and the saw has to be stopped before the cut is completed, press the Emergency Stop button.
10. If the sawblade has reached its full speed, you can push down the saw bow.

Please be careful! Feed the bow slowly and with normal force. High force will damage the sawblade and the saw.

11. In case of any emergency, press the red palm-EMG-button at the control box. The saw will stop immediately. To release the EMG-switch, please turn the palm-button and release it.

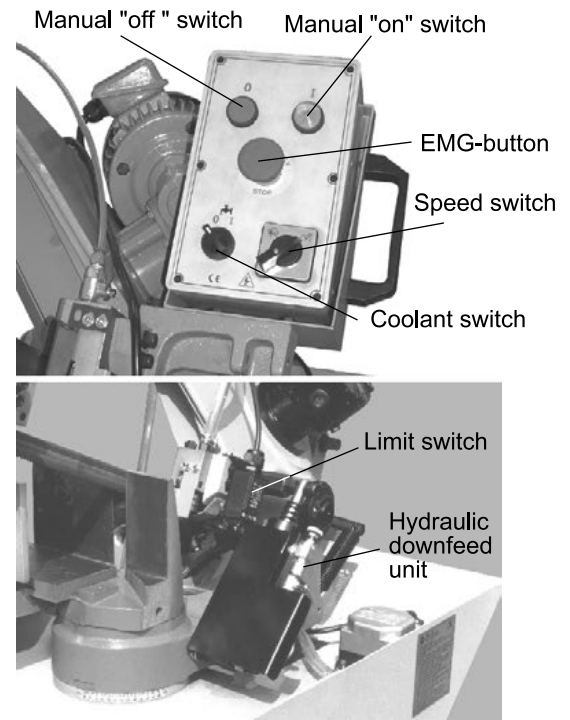

INCLINED CUTS

If you wish to make inclined cuts, release the lever and turn the bow according to the desired angle and clamp the lever again.

REPLACEMENT OF THE BLADE

ATTENTION!

Before doing any maintenance or servicing switch off and unplug the machine.

1. Lift the bow completely.
2. Secure the cutting head (by safety lever)!
3. Loosen the blade tension handwheel and remove the blade protection.
4. Replace the blade by inserting it first between the bearings of the blade guide heads and then by positioning it on the housings of the flywheels.

ATTENTION: Check the cutting direction of the blade teeth. It has to be according to the arrow at the bow. Tighten the blade again.

Blade tension: The correct blade tension is reached, if the sawblade can be pushed for 3 min the middle of the cutting area with a force of **50 N**. For this adjustment, the adjustable blade guide has to be at its most left position.

Please note! Incline the handle of the blade tension handwheel in such manner, that hitting of the handwheel of the vice is impossible.

Be careful! After any dismantling of the blade protection, be sure, that this cover is replaced and secured by the screws again. Do never manipulate the safety switch. Accidents may happen if this is disregarded.

MAINTENANCE

Attention! In each case before you will do any maintenance switch off the machine and unplug it. Secure the cutting head by the safety lever!

1. Lubricate the slide, the vice, and the blade guide periodically. Clean the coolant tank from the chips.
2. The reduction gear has already been lubricated with synthetic grease and, therefore, it does not require any maintenance.

IMPORTANT: At the end of each working day, it is necessary to loosen blade tension, unplug the machine and secure the cutting head (by safety lever)! Remember to put the blade under tension again when you resume your work.

ADJUSTMENT OF BLADE GUIDE BEARINGS

1. Unloose the nut and unscrew the dowel (ref.No.80), by increasing the gap between the blade and the bearings.
2. Then adjust the upper bearing; If necessary, unloose the screws on the arm (ref.No.74).
3. In order to adjust the pair of side bearings (ref.No.78), act on the dowel (ref.No.80) so that the bearings rest on the blade and, then, loose it as much as it is necessary to let the blade slide, by leaving a backlash of about 0.04 mm.
4. When the adjustment has been completed, tighten its nut.

ATTENTION:

Please make sure to always assemble 0.9 mm thick blades for which the bearings of the blade guide have been adjusted. In case of thicker blades, if is necessary to adjust the blade guide once again as above mentioned.

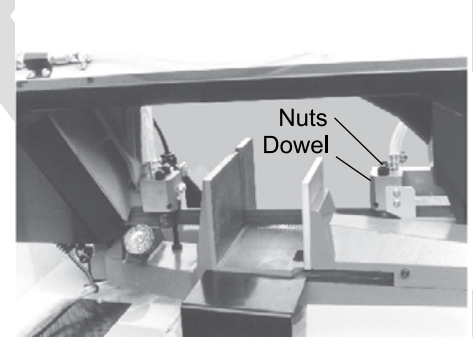
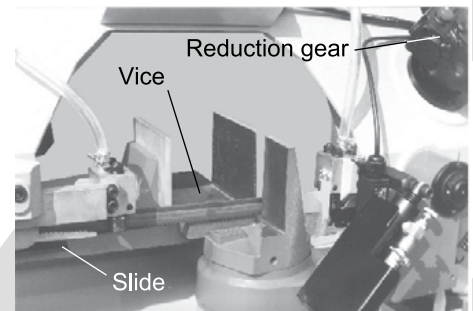
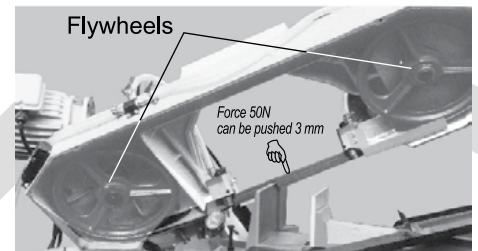
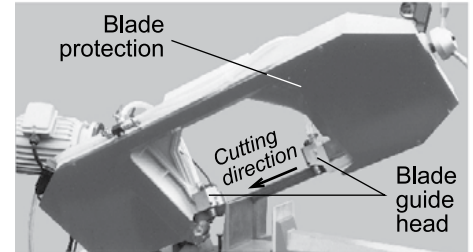
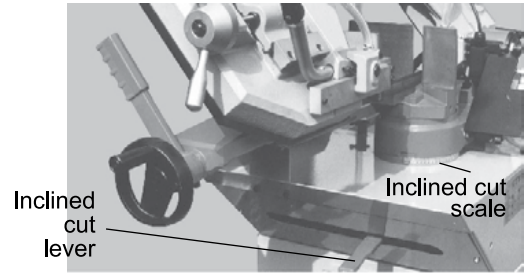

EXPLODED VIEW

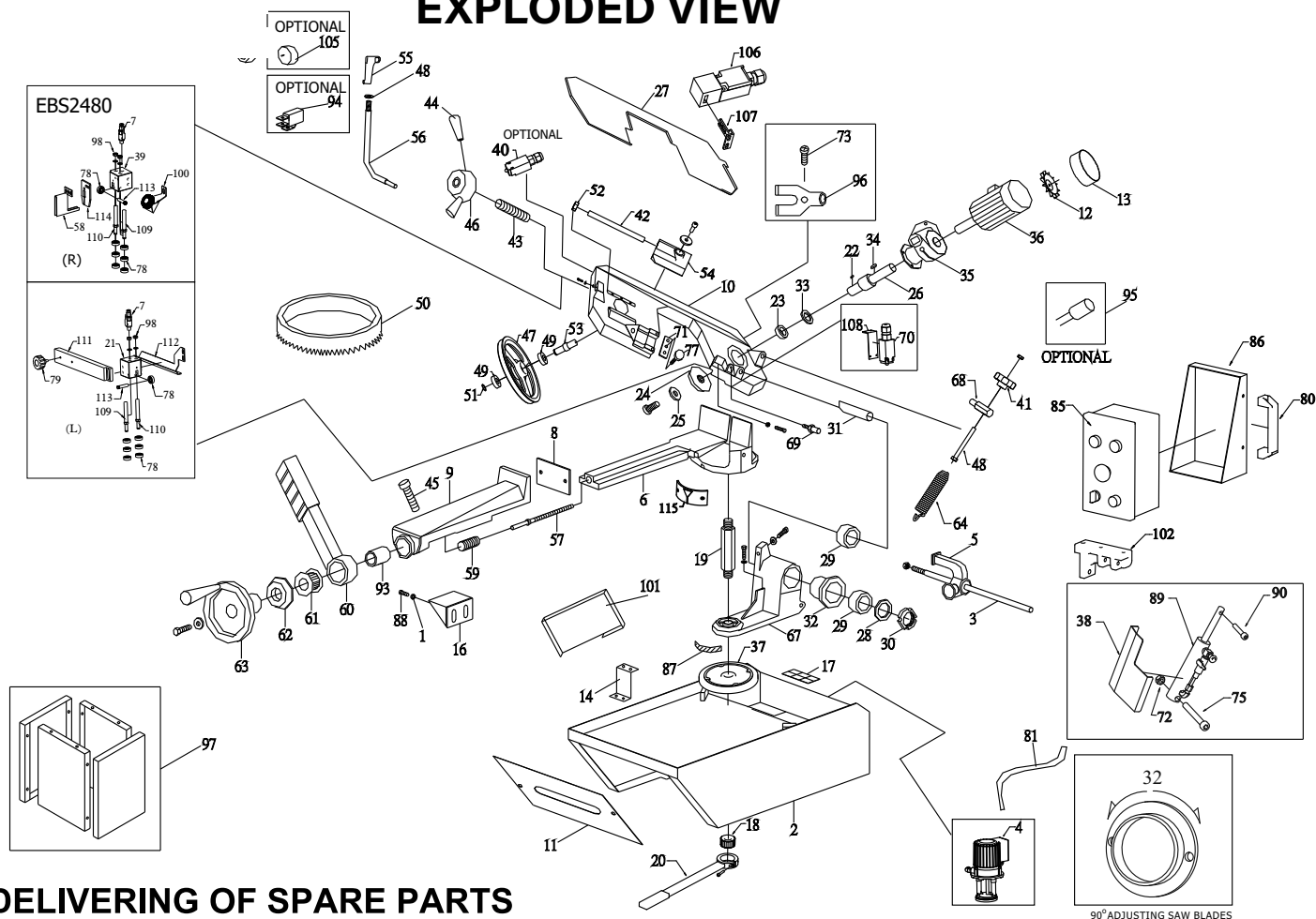

DELIVERING OF SPARE PARTS

Please note: When ordering spare parts please always mention: Model of the machine, Serial number and Reference number of the part
SHOULD REF. NUMBERS MISSING, NO SPARE PART WILL BE DELIVERED.

LIST OF SPARE PARTS

Ref. No.	Description	Ref. No.	Description	Ref. No.	Description	Ref. No.	Description
01	Washer	31	Pivot	60	Vice lever	91	Fixed blade guide plate
02	Base	32	Bearing cover	61	Bearing	92	Mobile blade guide plate
03	Bar stop rod	33	Washer	62	Bearing cover	93	Bush
04	Cool pump	34	Key 8 x 7 x 25 mm	63	Vice handwheel	94	Toger switch
05	Bar stop	35	Reducer	64	Spring	95	Condenser(Motor) (optional)
06	Countervice	36	Motor	65	Spring connection	96	Coolant distributor
07	Valve	37	round table	67	Revolving arm	97	Stand
08	Vice jaw	38	Plate(optional)	68	Rod	98	Nut M10
09	Vice	39	Mobile blade guide plate	69	Stop bolt	99	Pivots centric
10	Body frame	40	Switch(optional)	70	Micro switch(optional)	100	Brush
11	Casing	41	hand wheel	71	Block	101	Plate
12	Motor Fan	42	Threaded shaft	72	Hex. nuts	102	Bracket
13	Motor	43	Spring washer	73	Rubber connection	104	Pivots excetric
14	Connection	44	Grip	74	Arm	105	Blade Tension Gauge (optional)
16	Arm	45	Pin	75	Bolt	106	Switch
17	Filter	46	Handwheel	76	Blade guard	107	Key
18	Bush	47	Return flywheel	77	Handle	108	block
19	Pin	48	Hex. Nut	78	Bearing 6082Z	109	Pivots centric
20	Lever	49	Bearings 2Z/6205	79	Hand wheel	110	Pivots excetric
21	Fixed blade guide plate	50	Saw blade	80	Handle	111	ARM
22	Key 7x7x35mm	51	C-ring	81	Water Pipe	112	Blade guard
23	Bearing	52	Hex. nuts.	82	Rust Plate	113	PIN
24	Motor flywheel	53	Blade sheel shaft	83	L. Bladeguard	114	Rust Plate
25	Washer	54	Block blade tension	84	Switch set	115	Scale
26	Shaft	55	Handle	85	Brush (optional)		
27	Blade cover	56	Lever	86	Switch Shelf		
28	Ring nilons	57	Vice screw	87	Scale		
29	Bearing 32006	58	R. Bladeguard	89	Cylinder(optional)		
30	Ring nut M30	59	Vice spring	90	Pin(optional)		

ELECTRICAL CIRCUIT DIAGRAM

Rexom fuse 16A
Power Supply
3 PH / 50HZ / 400V
LIMIT OF EQUIPMENT

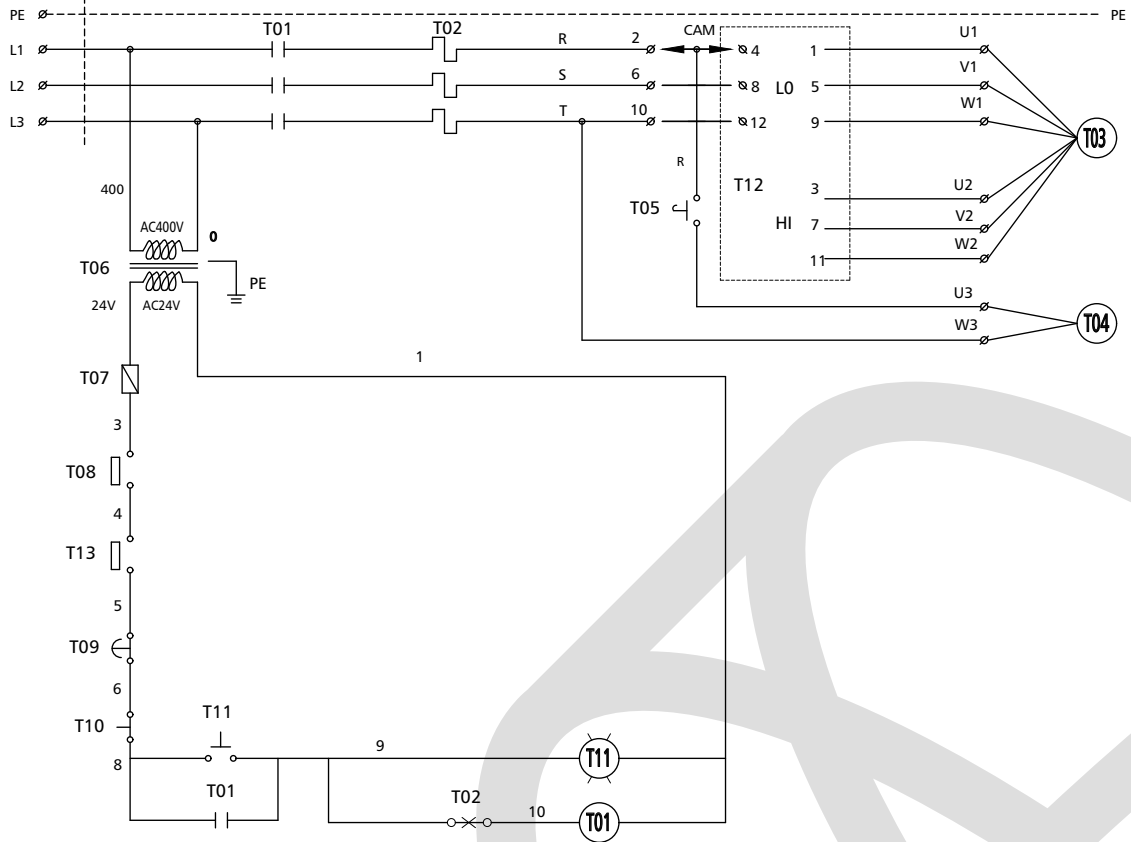

Electrical parts list

Part No	Name	Dscription	Mark
T01	MS1	MS	CE
T02	O.L	OVER RELAY	CE
T03	M1	SAW MOTOR	CE
T04	M2	PUMP MOTOR	CE
T05	COOL	COOL SWITCH	CE
T06	PT	POWER TRANSFORMER	CE
T07	F1	FUSE	CE
T08	SAFE MICRO 1	MICRO SWITCH	CE
T09	EMS	EMERGENCY STOP	CE
T10	OFF	PUSH BUTTON	CE
T11	ON	PUSH BUTTON	CE
T12	SPEED	CAM SWITCH	CE
T13	SAFE MICRO2	MICRO SWITCH	CE

TROUBLE SHOOTING

P: When the blade is not in a 90° angle (A)

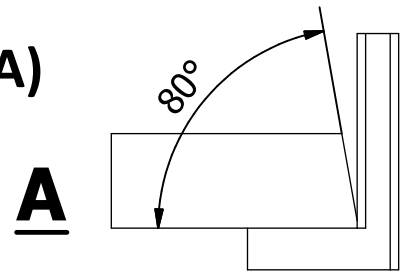

S: Replace your saw, so it makes a 90° angle (B)

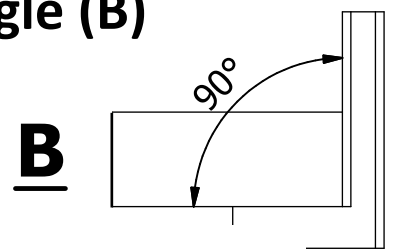

S: Inspect the blade guide plate if it is in a 90° (D1,D2,D3)

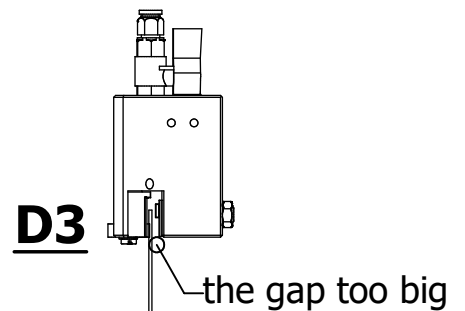
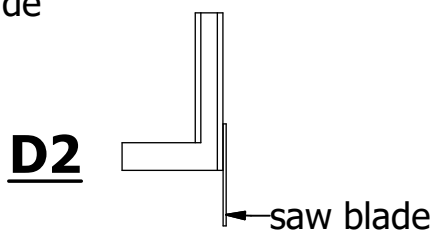
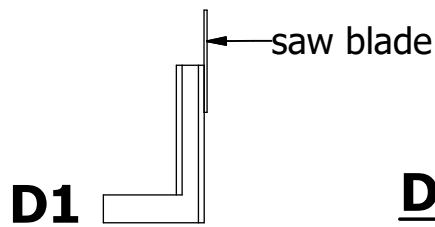

S: Use #32 to adjust the blade and set it 90°

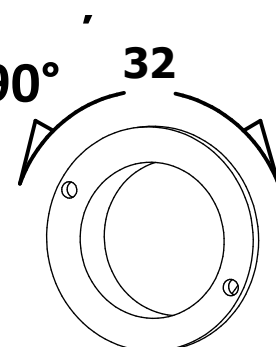

90° adjusting saw blade

